

(1 : 40)

Dräneringshål

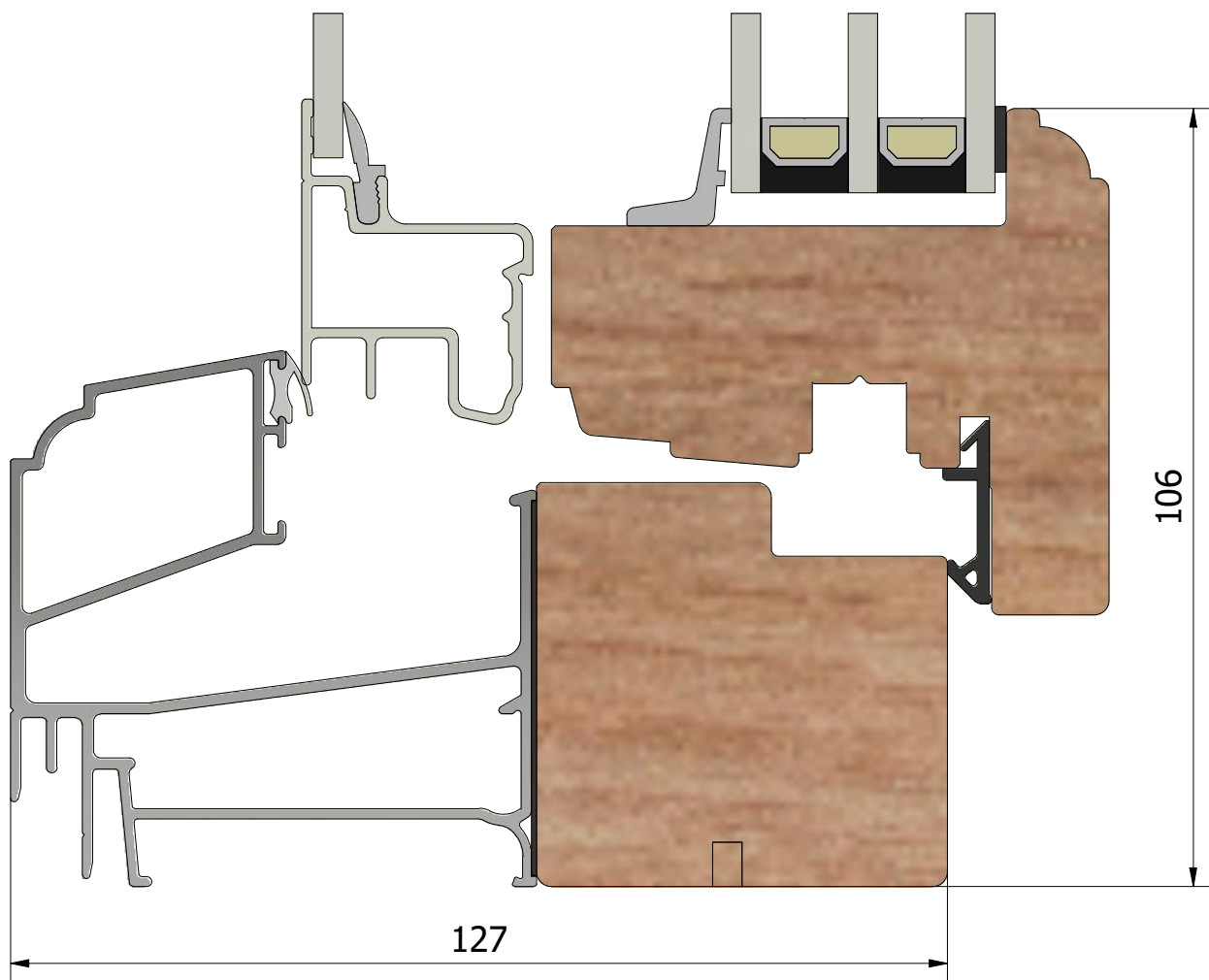
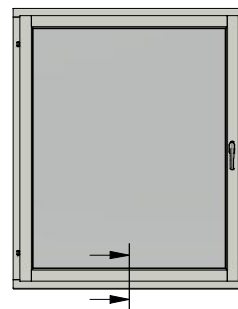
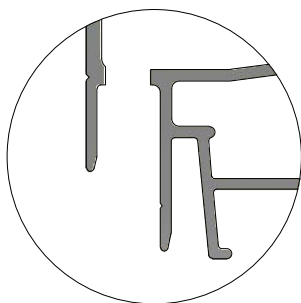

LEIAB

Vyplacering

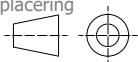
Filnamn
MP-LIF1274.2_211.dwgRitningsnr.
MP-LIF1274.2_211Ritn. storlek
A4Skala
1 : 1Sida
2Beskrivning
Epok inåtgående fönster 3+1Generell tolerans
SS-ISO 2768-1, mProduktnamn
LIF1274.2Skapad av
ThomasNSkapad datum
2021-04-07

Revisionsnr. Revisionsbeskrivning

(1 : 40)

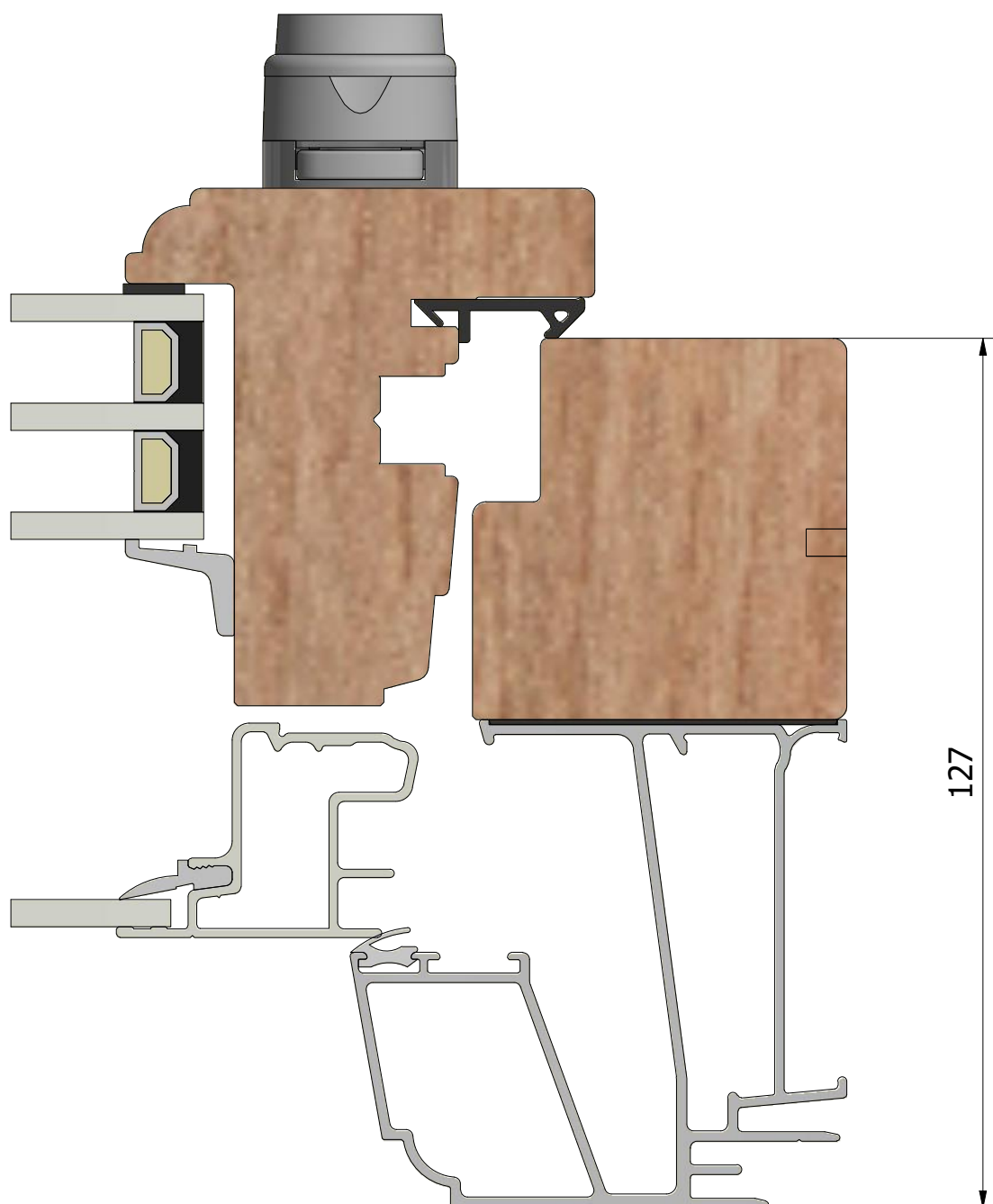
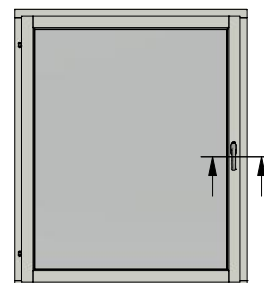

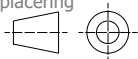

(1 : 40)

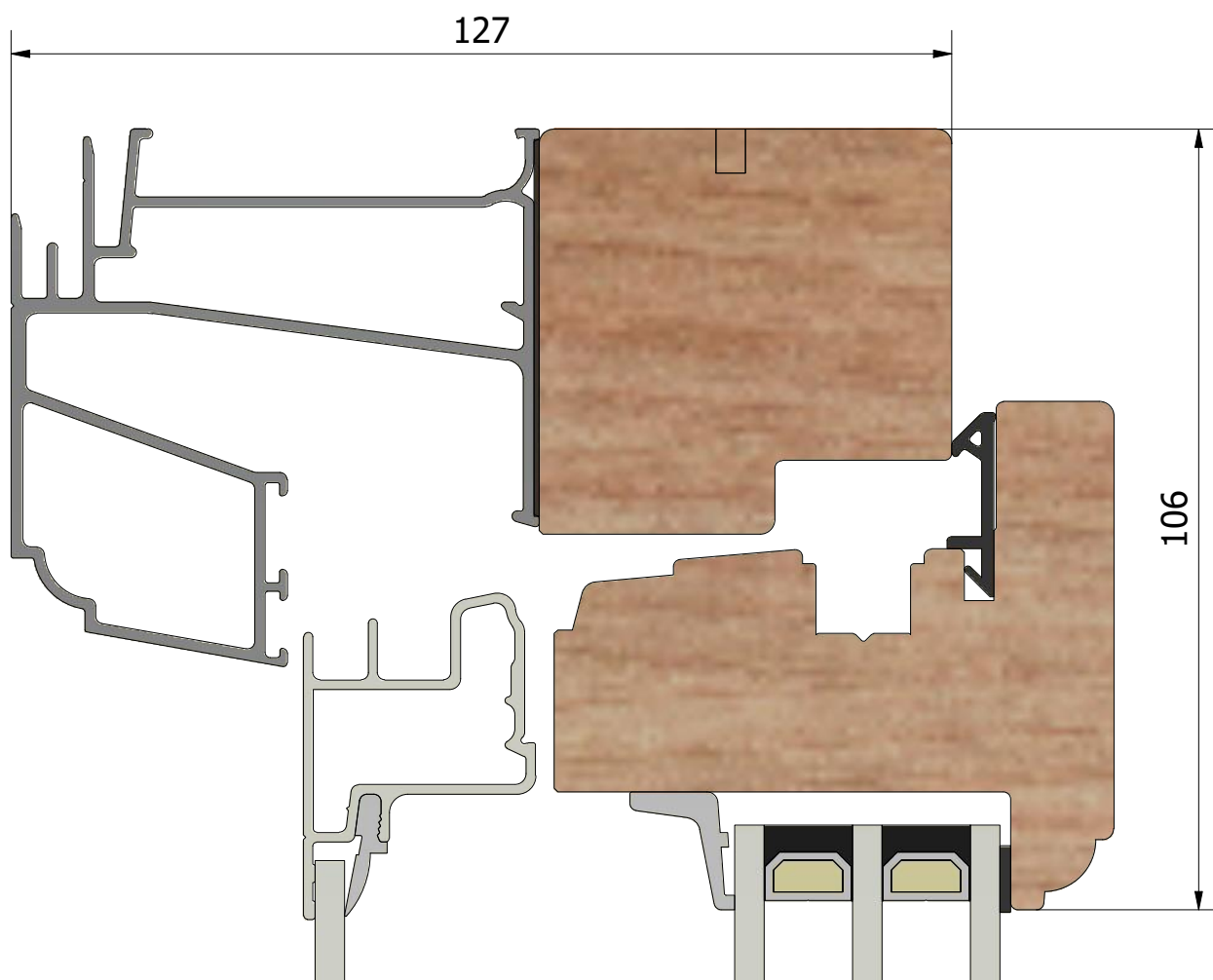
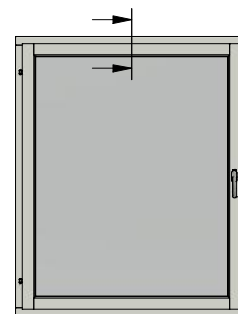

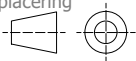

(1 : 40)

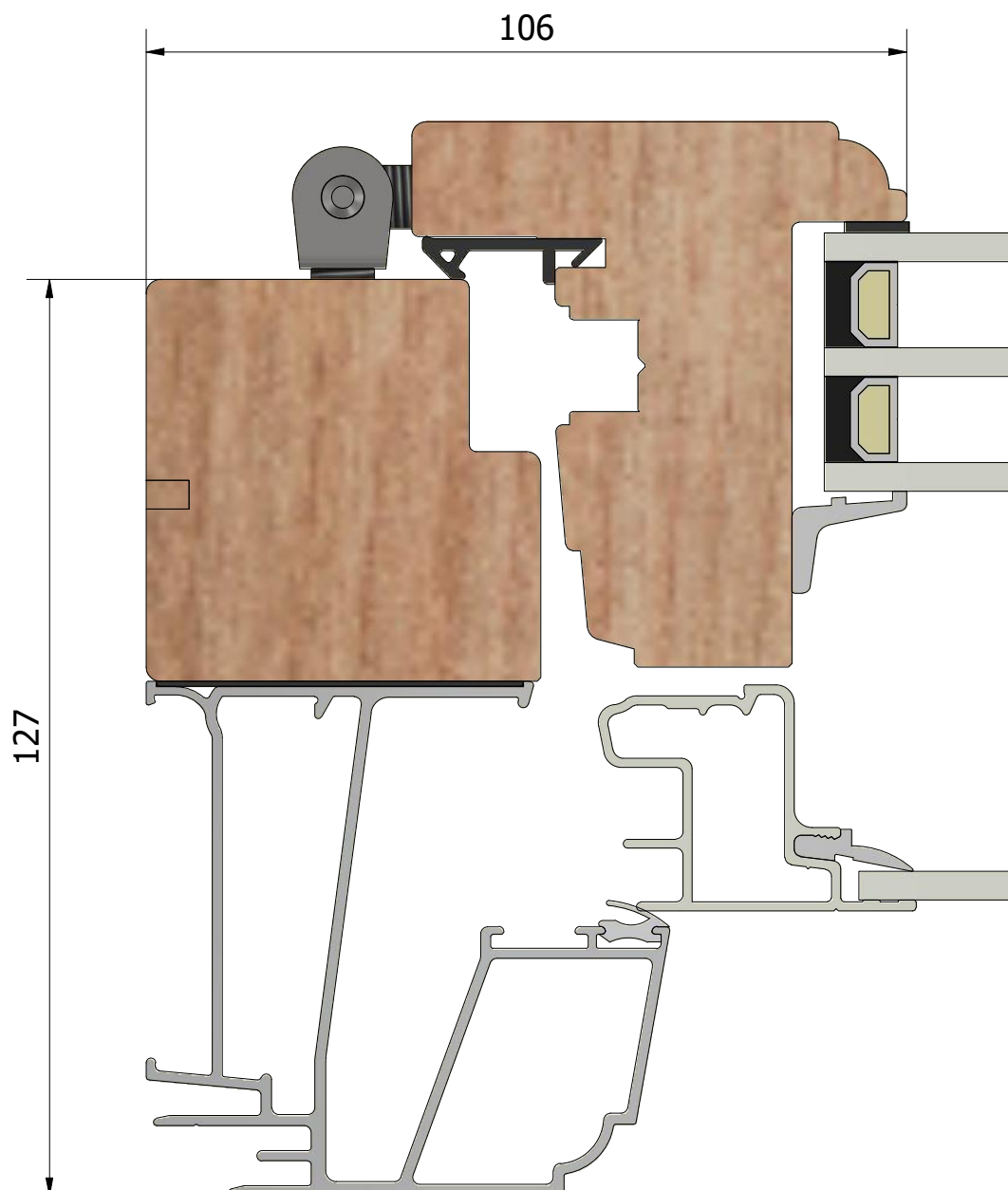
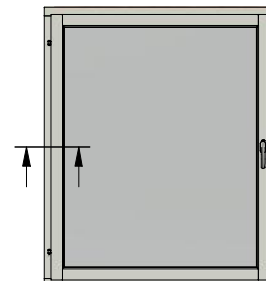

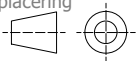

(1 : 40)

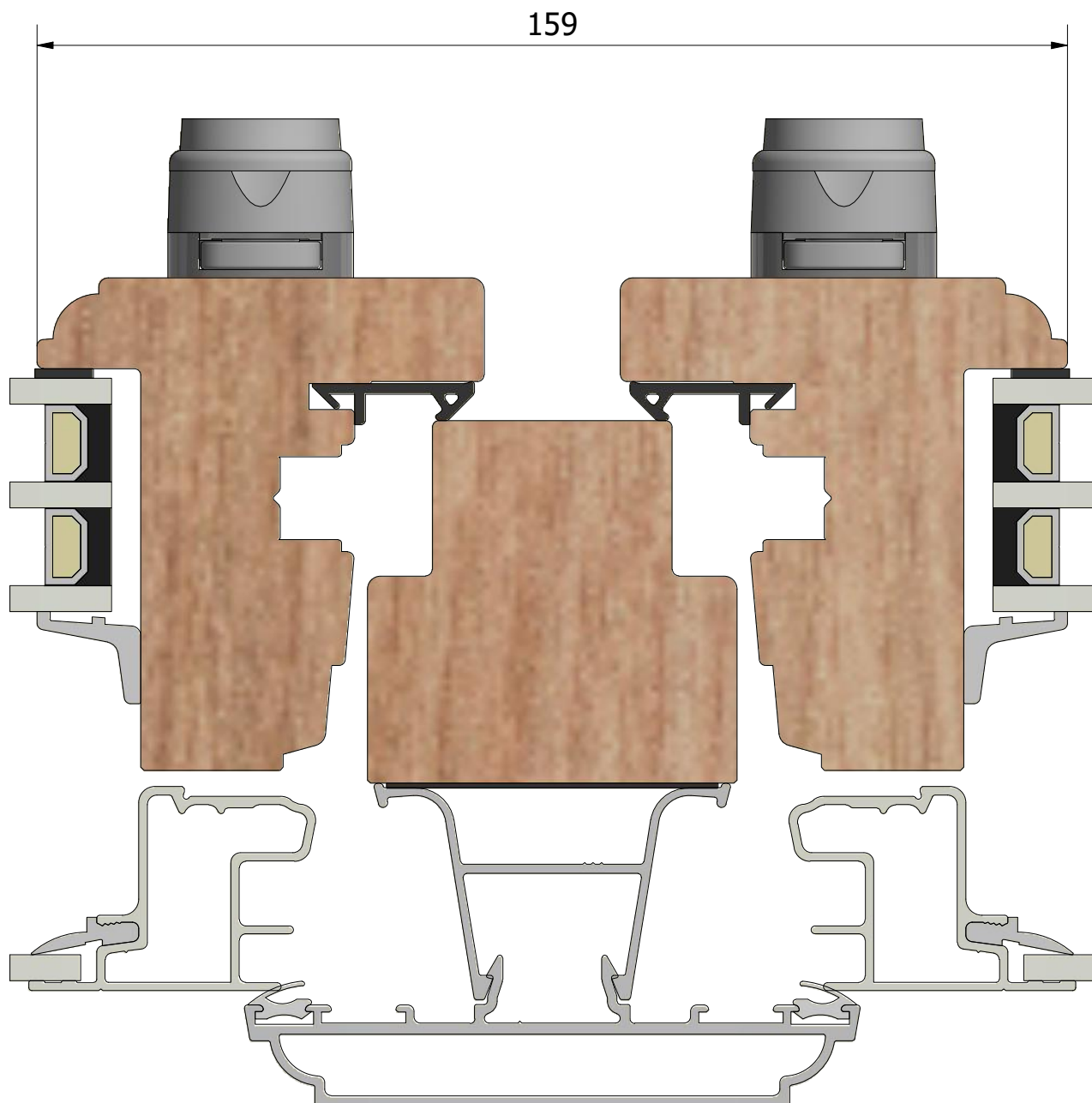
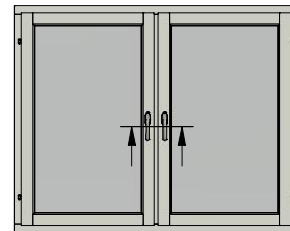

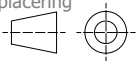

(1 : 40)

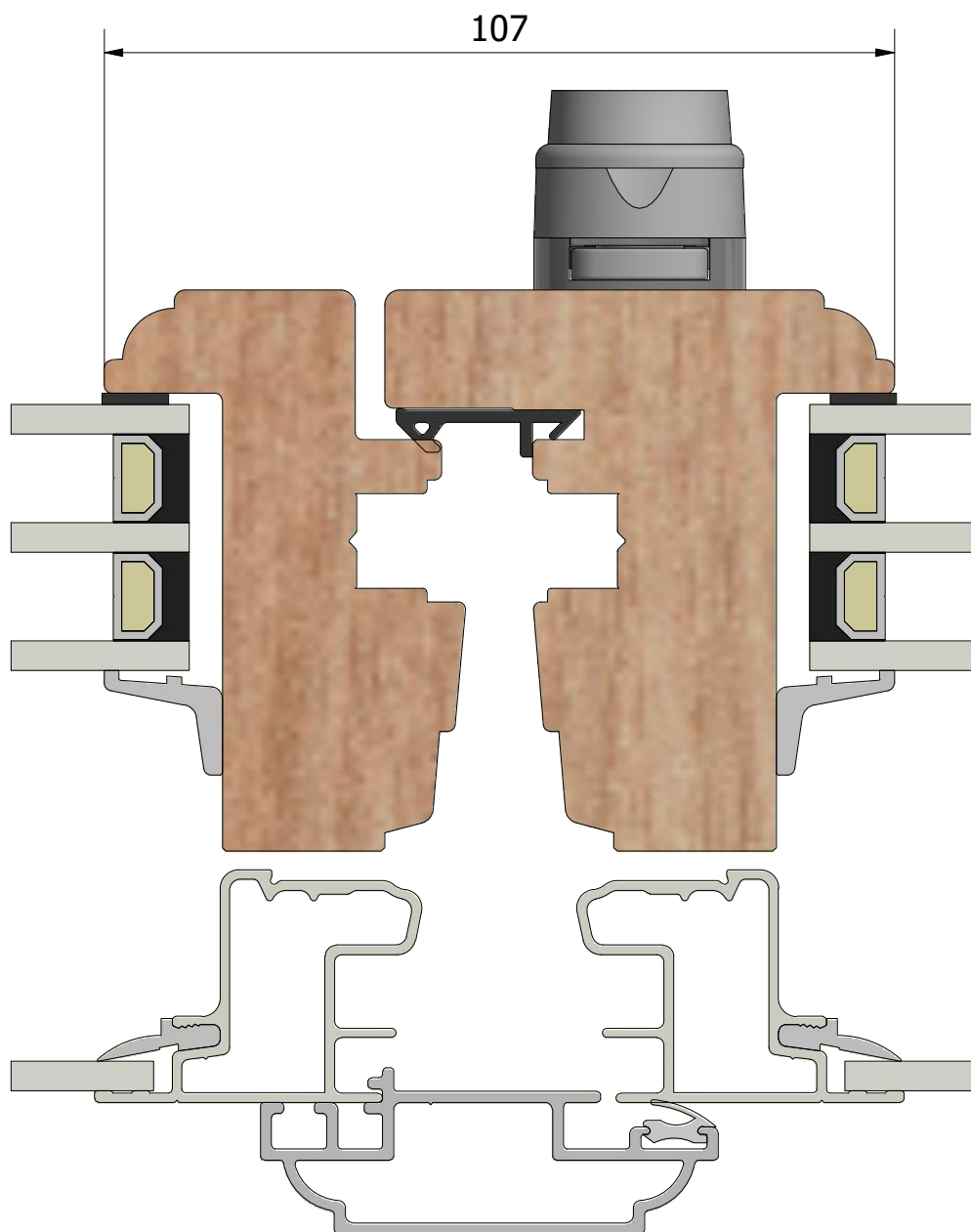
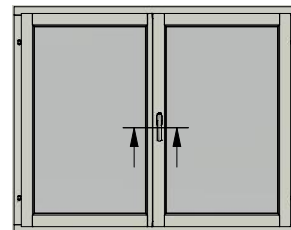

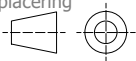

(1 : 40)

