

Dräneringshål

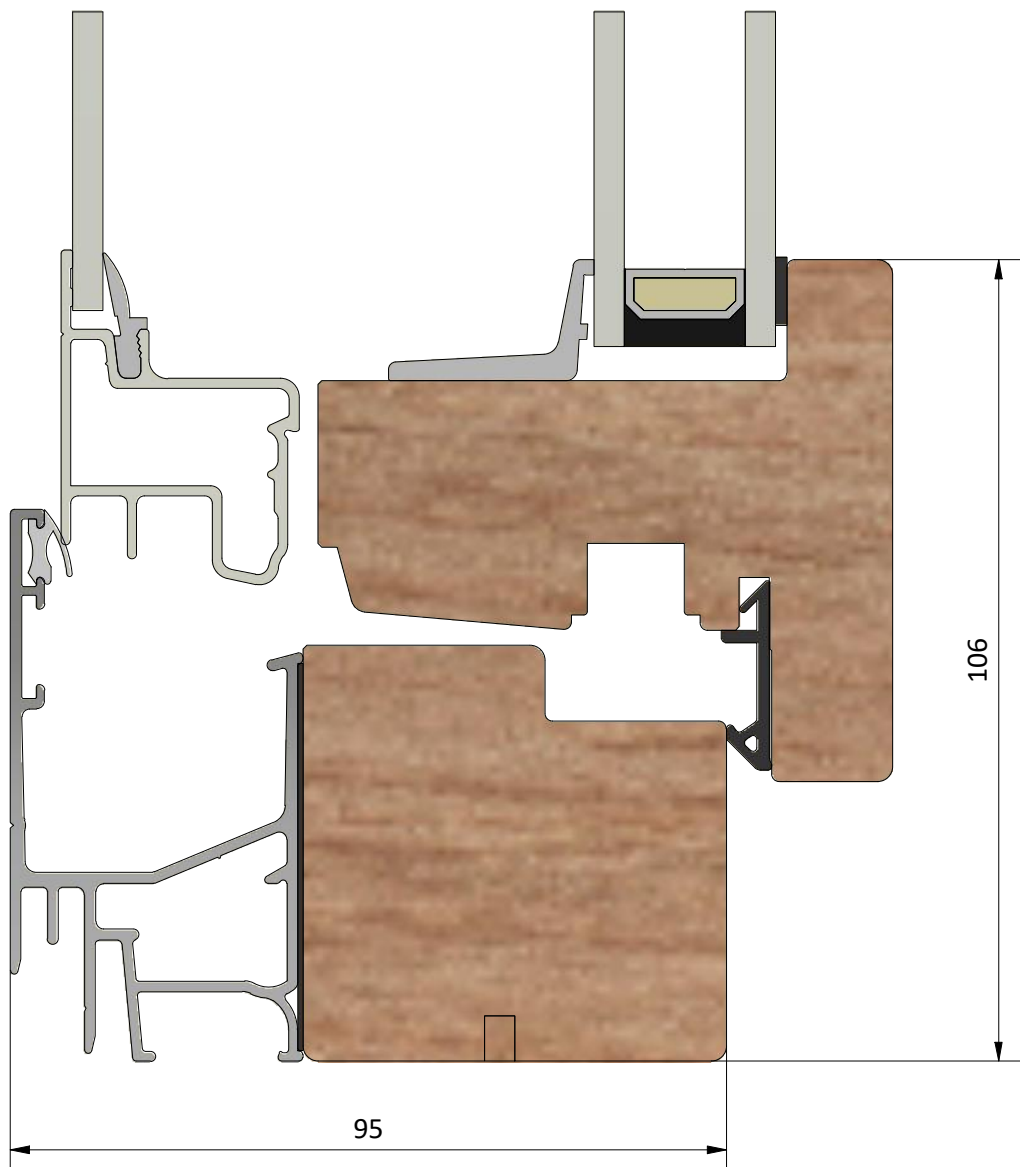

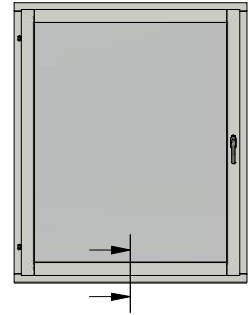
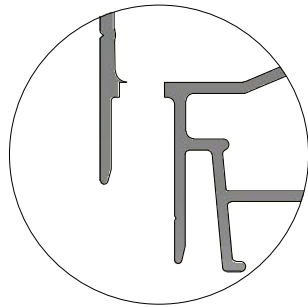

LEIAB Fönster AB  
Mariannelund  
Sverige  
www.leiab.se

Titel / title <b>Stil 2+1</b> <b>Inåtgående fönster</b>		Modell / model <b>LIF951</b> <b>Överstycke</b>	
Skala / scale <b>1:1</b>	Sida / page <b>2</b>	Ritad av / author <b>thomasn</b>	Rev.
Datum / date <b>2020-01-02</b>		Ritningsnamn / drawing name <b>LIF951.dwg</b>	

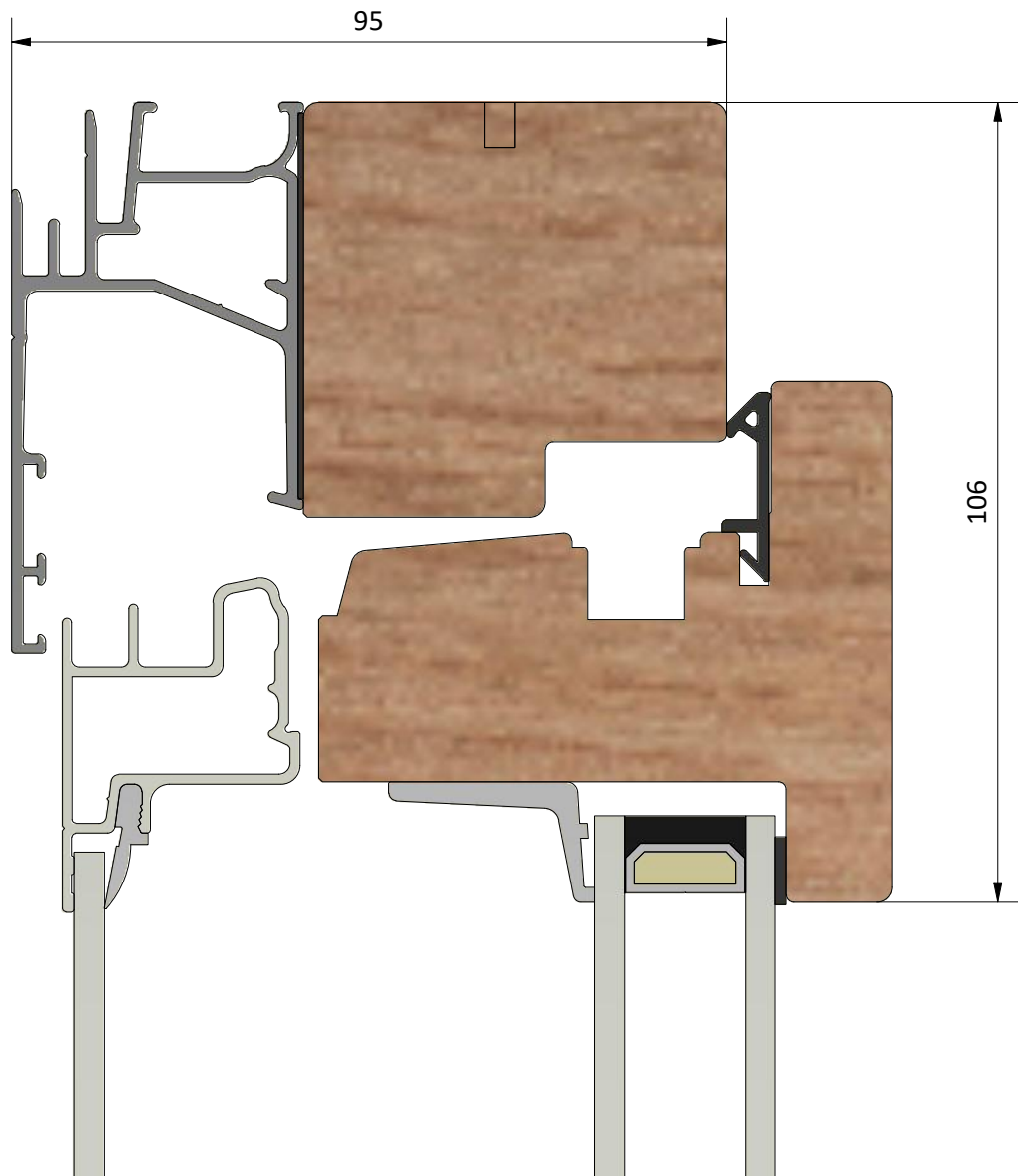
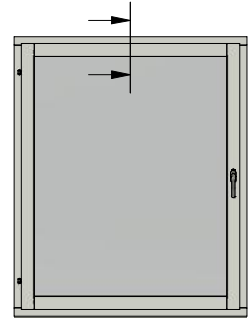

Detalj handtag

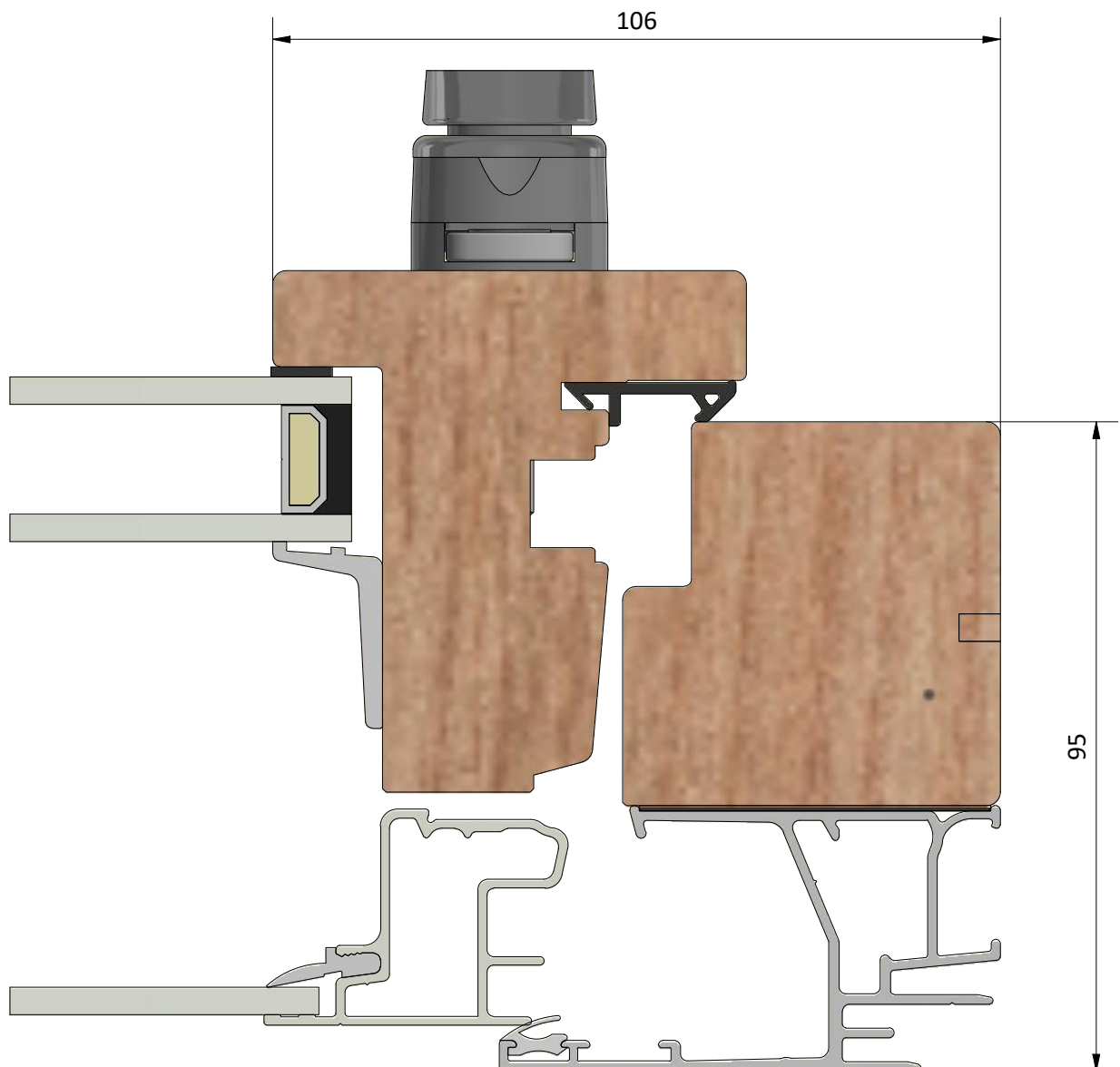
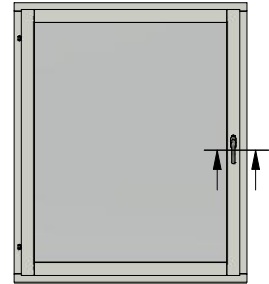

Detalj gångjärn

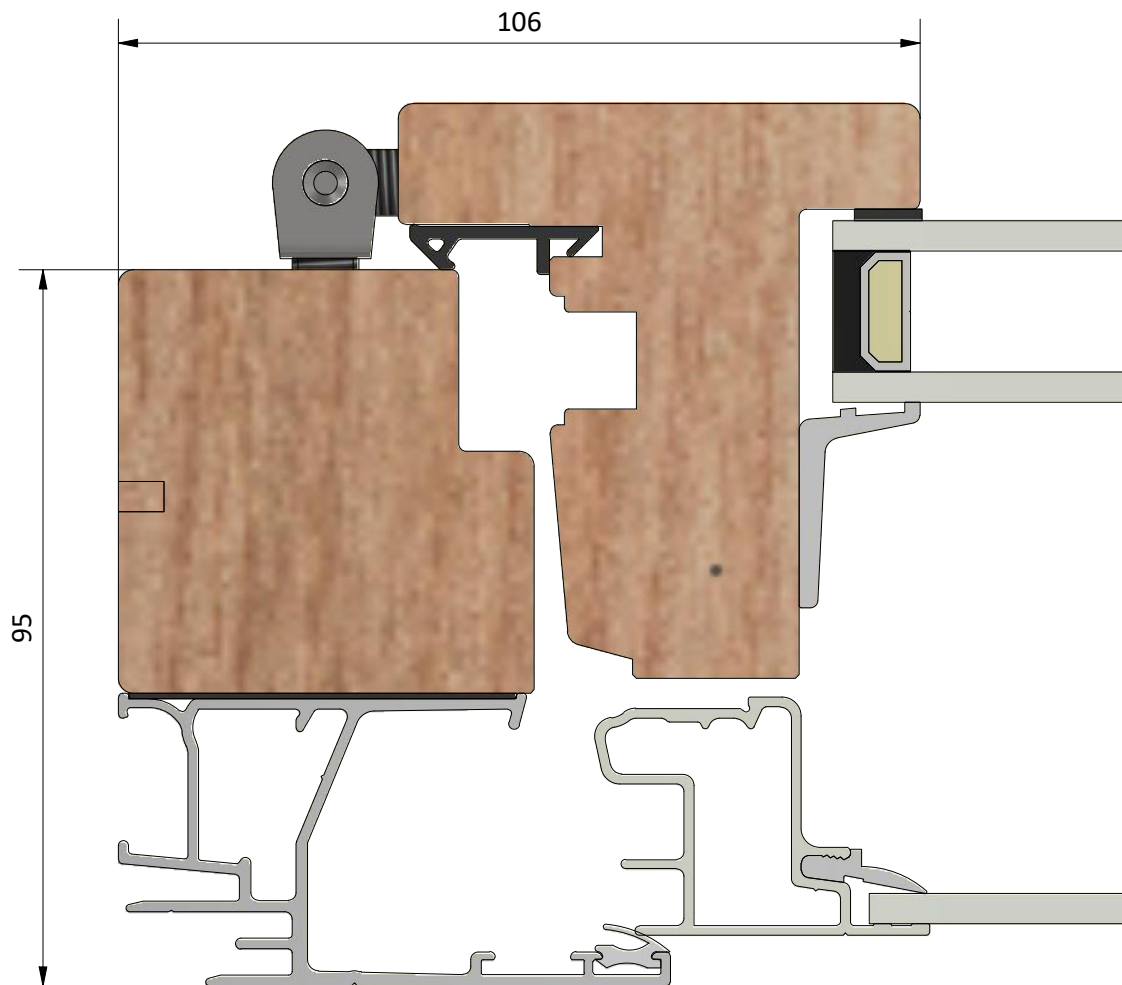
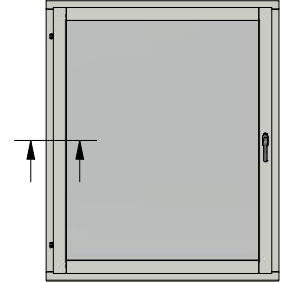
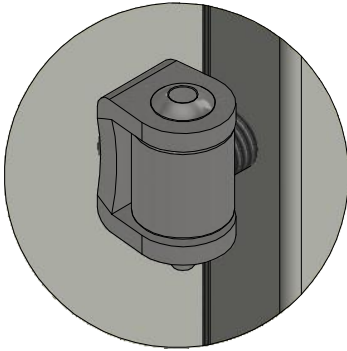

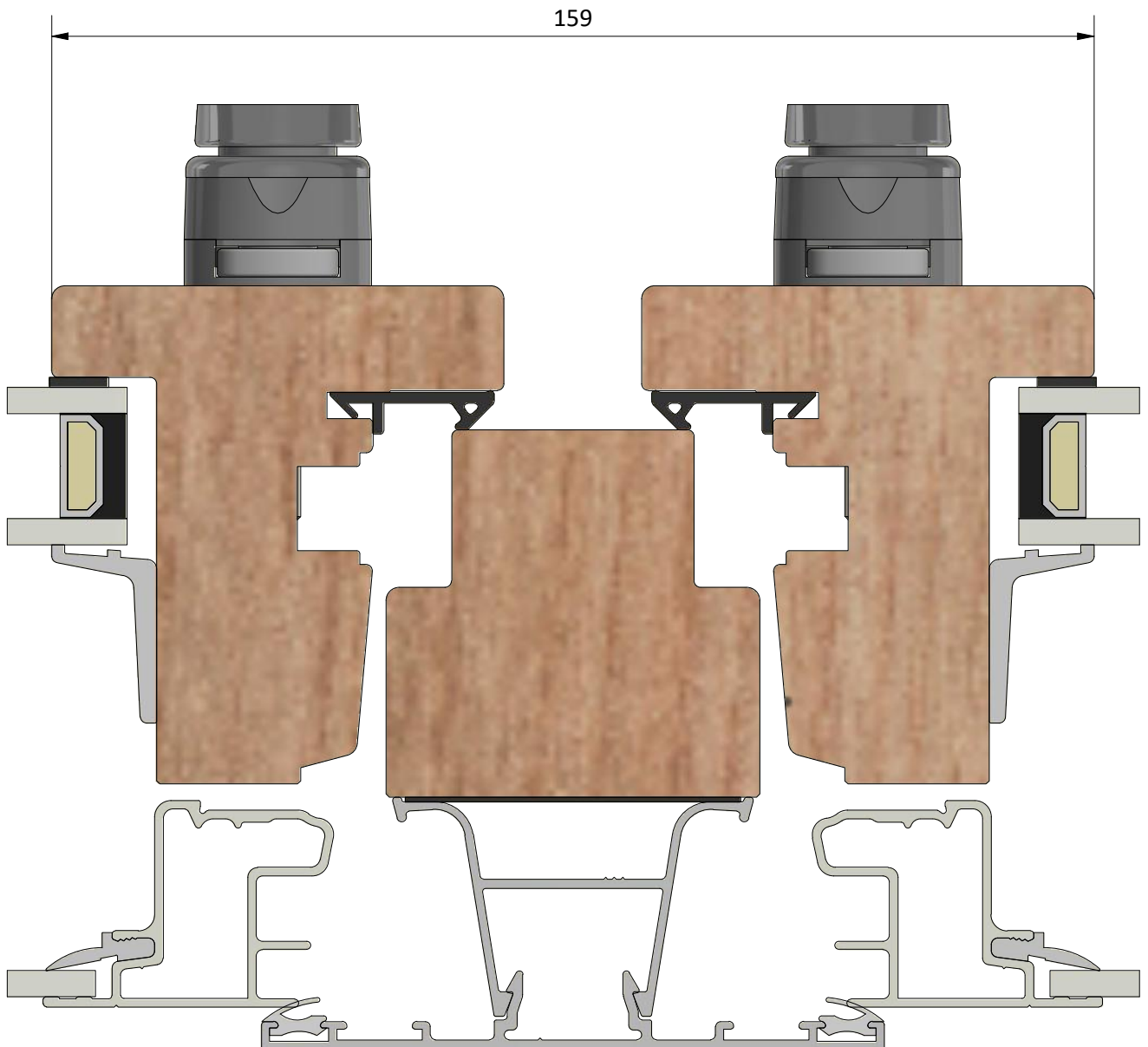
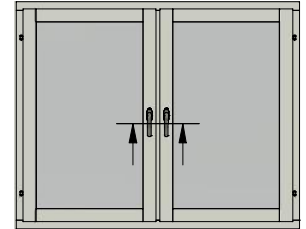



LEIAB Fönster AB  
Mariannelund  
Sverige  
www.leiab.se

Titel / title  
**Stil 2+1**  
**Inåtgående fönster**

Modell / model  
**LIF951**  
**Mötesbåge**

Skala / scale  
1:1

Sida / page  
6

Ritad av / author

Rev.

Datum / date  
2020-01-02

Ritningsnamn / drawing name  
LIF951.dwg

