

# SKALLEVOLD SYSTEM

Dato: 2015.03.19

Horisontal snitt

Teg.nr. 1050 - 2015

Skyvedør

M=1:1

firmapost@skallevold.no  
tel (+47) 33 37 22 50  
fax (+47) 33 37 22 51

Erstattet av:

Erstatning for:

**Skyvedør - dørmøte**

**Skallevold Trevaresalg AS**  
Granborgveien 5  
N-3153 TOLVSRØD, NORWAY

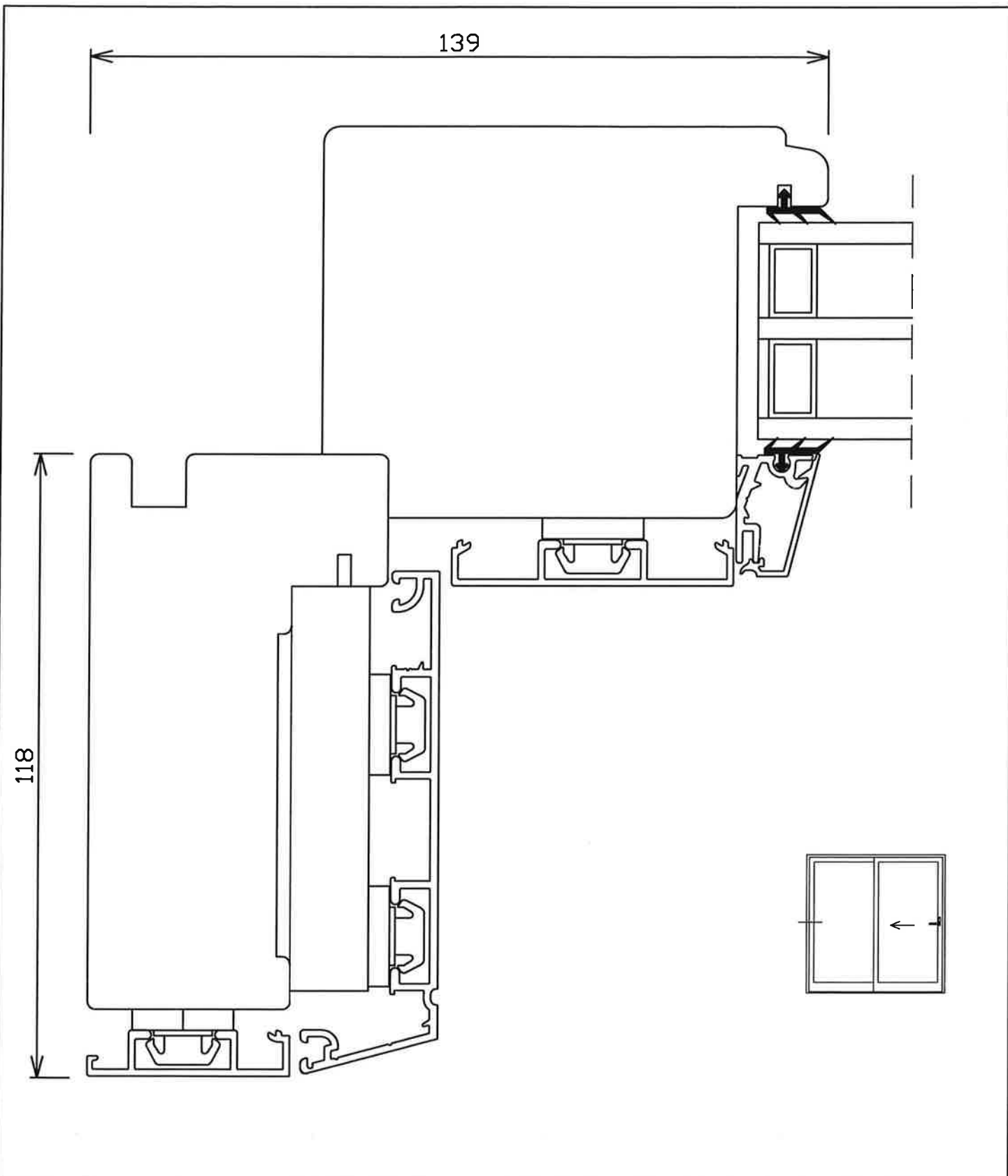

# SKALLEVOLD SYSTEM

Dato: 2015.03.19

Horisontal snitt

Teg.nr. 1051 - 2015

Skyvedør

M=1:1

firmapost@skallevold.no  
 tel (+47) 33 37 22 50  
 fax (+47) 33 37 22 51

Erstattet av:

Erstatning for:

Sidekarm og fast ramme

Skallevold Trevaresalg AS  
 Granborgveien 5  
 N-3153 TOLLVSRØD, NORWAY

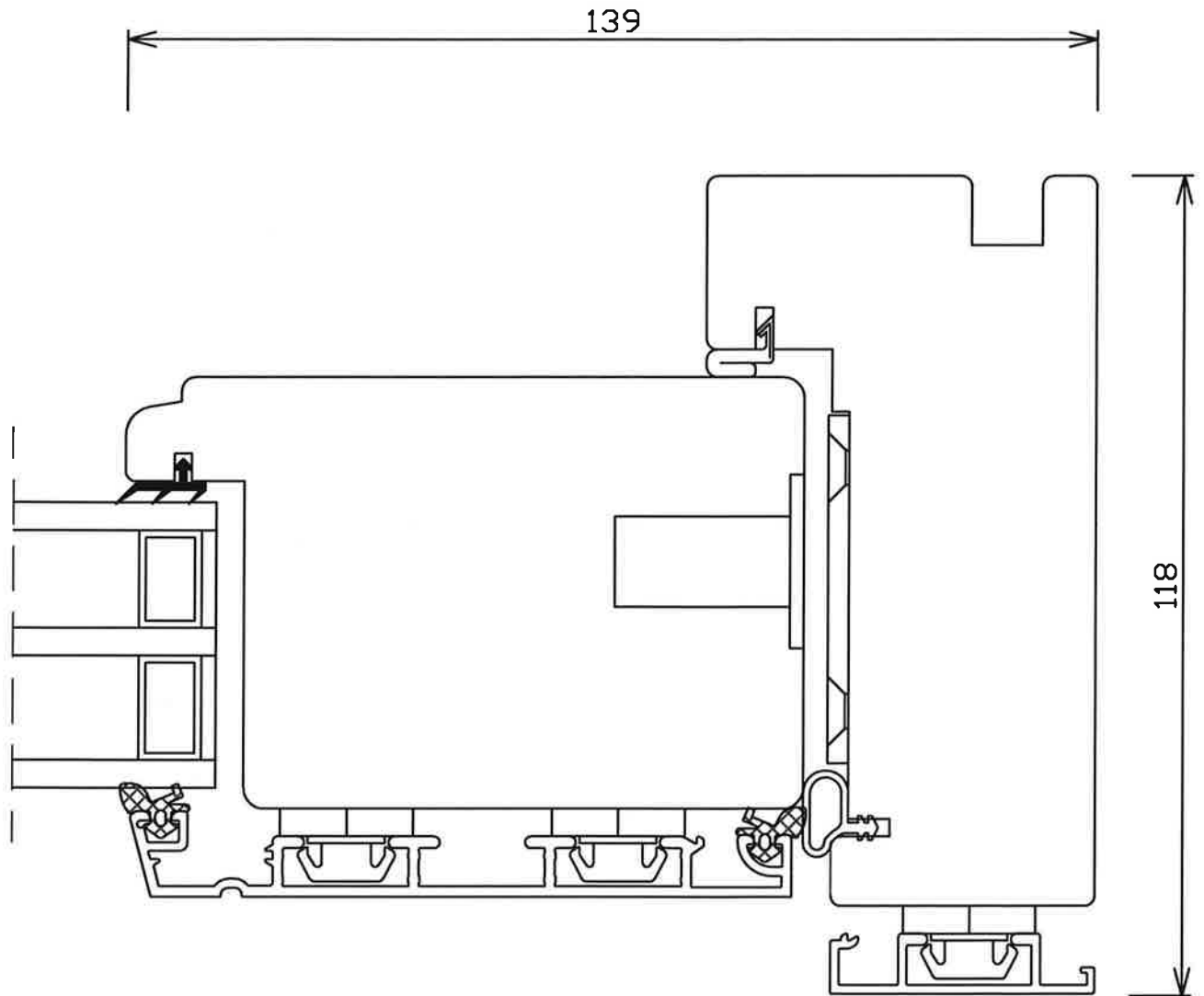
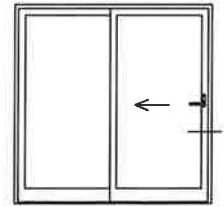

# SKALLEVOLD SYSTEM

Dato: 2015.03.19

Horisontal snitt

Teg.nr. 1052 - 2015

Skyvedør

M=1:1

firmapost@skallevold.no  
tel (+47) 33 37 22 50  
fax (+47) 33 37 22 51

Erstattet av:

Erstatning for:

Sidekarm og åpnings ramme

Skallevold Trevaresalg AS  
Granborgveien 5  
N-3153 TOLLVSRØD, NORWAY

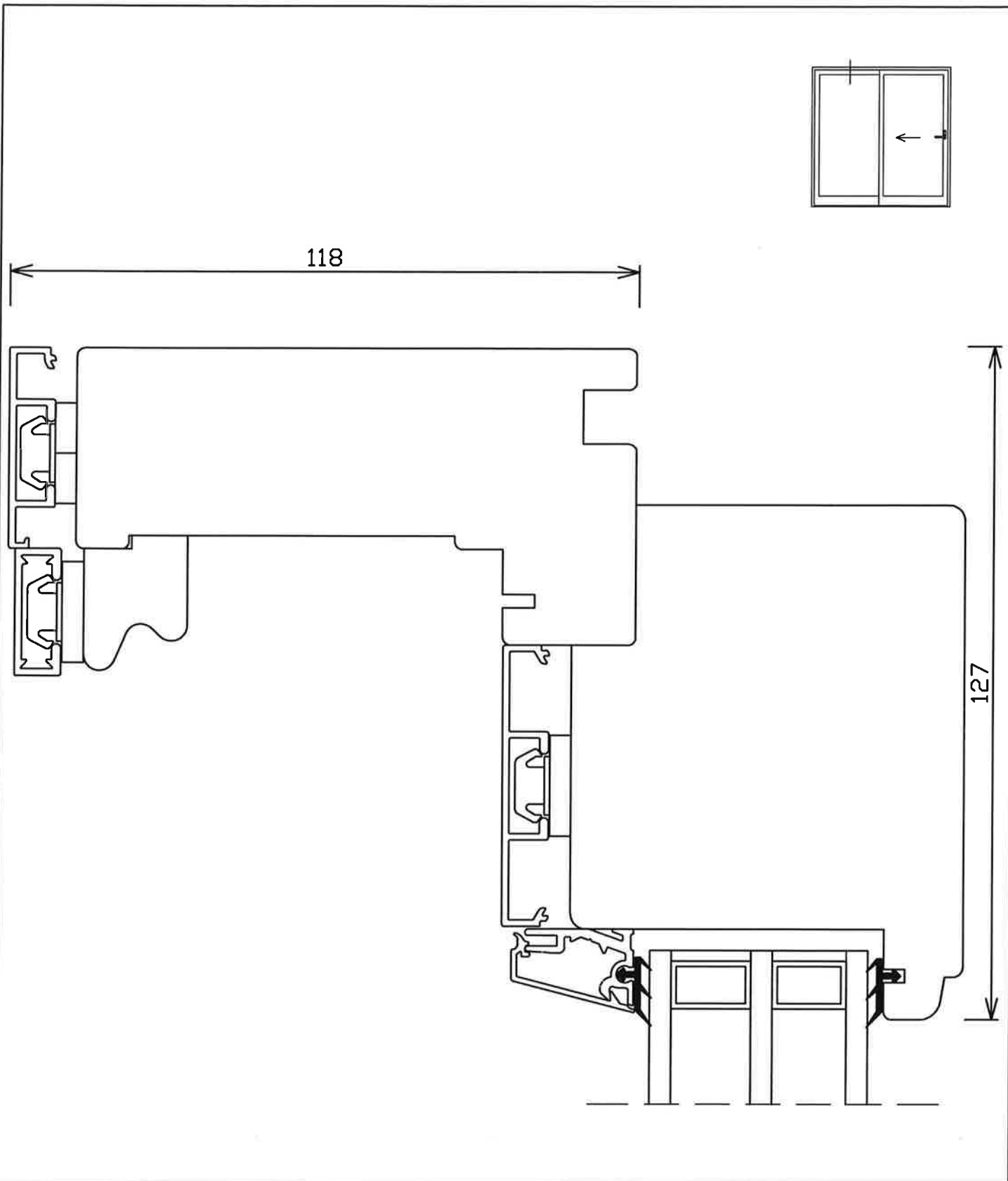

# SKALLEVOLD SYSTEM

Dato: 2015.03.19

Vertikal snitt

Teg.nr. 1053 - 2015

Skyvedør

M=1:1

firmapost@skallevold.no  
tel (+47) 33 37 22 50  
fax (+47) 33 37 22 51

Erstattet av:

Erstatning for:

**Toppkarm og fast ramme**

**Skallevold Trevaresalg AS**  
Granborgveien 5  
N-3153 TOLVSRØD, NORWAY

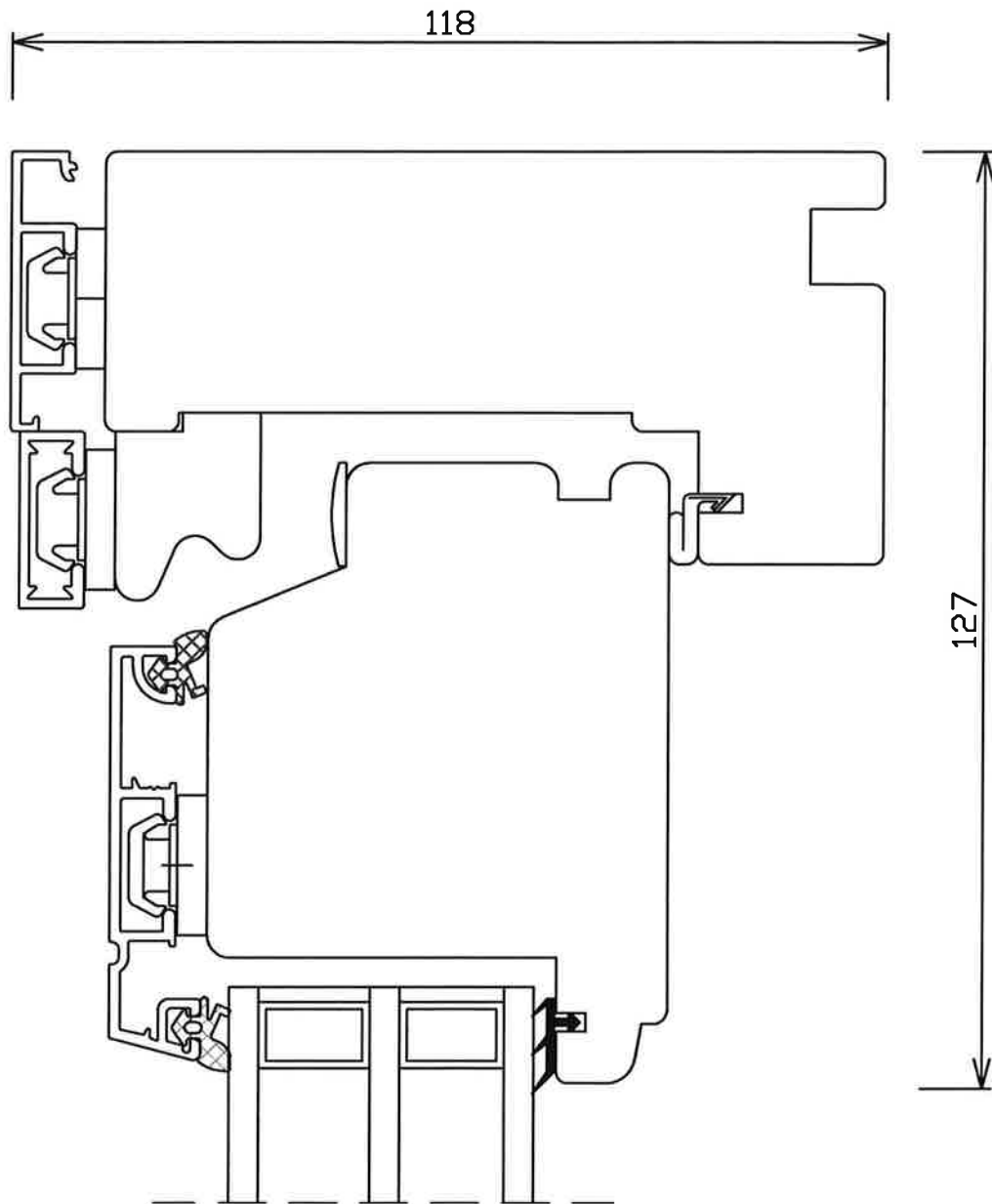
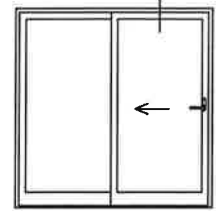

# SKALLEVOLD SYSTEM

|                                 |                |              |  |
|---------------------------------|----------------|--------------|--|
| Dato: 2015.03.19                | Vertikal snitt | <b>M=1:1</b> | firmapost@skallevold.no  |
| Teg.nr. 1054 - 2015             | Skyvedør       |              | tel (+47) 33 37 22 50<br>fax (+47) 33 37 22 51                                 |
| <b>Toppkarm og åpningsramme</b> |                |              | Erstattet av:  |
|                                 |                |              | Erstatning for:  |
|                                 |                |              | <b>Skallevold Trevaresalg AS</b><br>Granborgvelen 5<br>N-3153 TØLVSRØD, NORWAY |

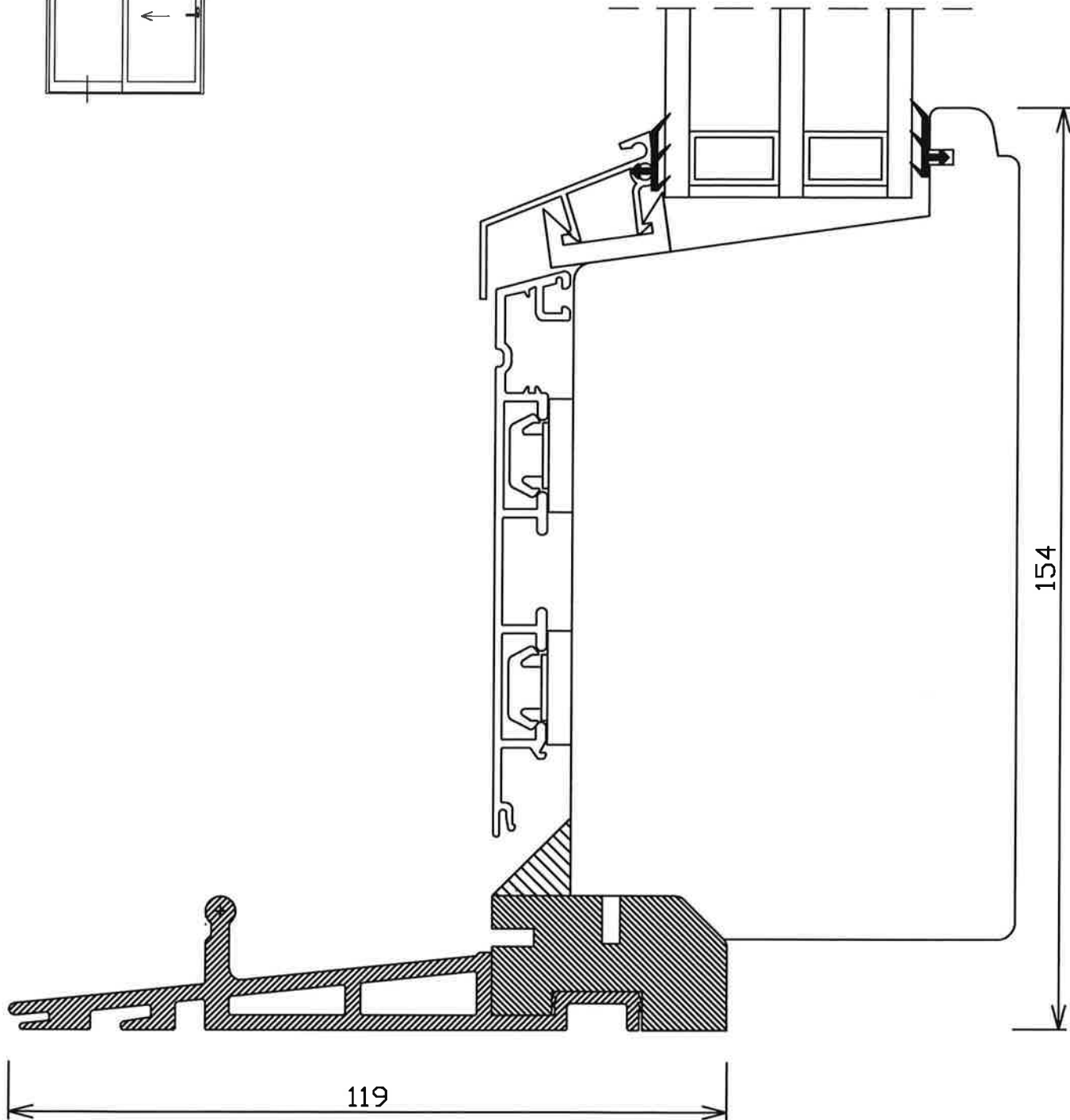
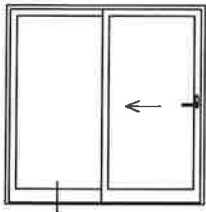

# SKALLEVOLD SYSTEM

|                              |                |              |   |
|------------------------------|----------------|--------------|---|
| Dato: 2015.03.19             | Vertikal snitt | <b>M=1:1</b> | firmapost@skallevold.no   |
| Teg.nr. 1055 - 2015          | Skyvedør       |              | tel (+47) 33 37 22 50<br>fax (+47) 33 37 22 51                          |
| <b>Terskel og fast ramme</b> |                |              | Erstattet av:   |
|                              |                |              | Erstatning for:   |
|                              |                |              | Skallevold Trevaresalg AS<br>Granborgvelen 5<br>N-3153 TOLVSRØD, NORWAY |

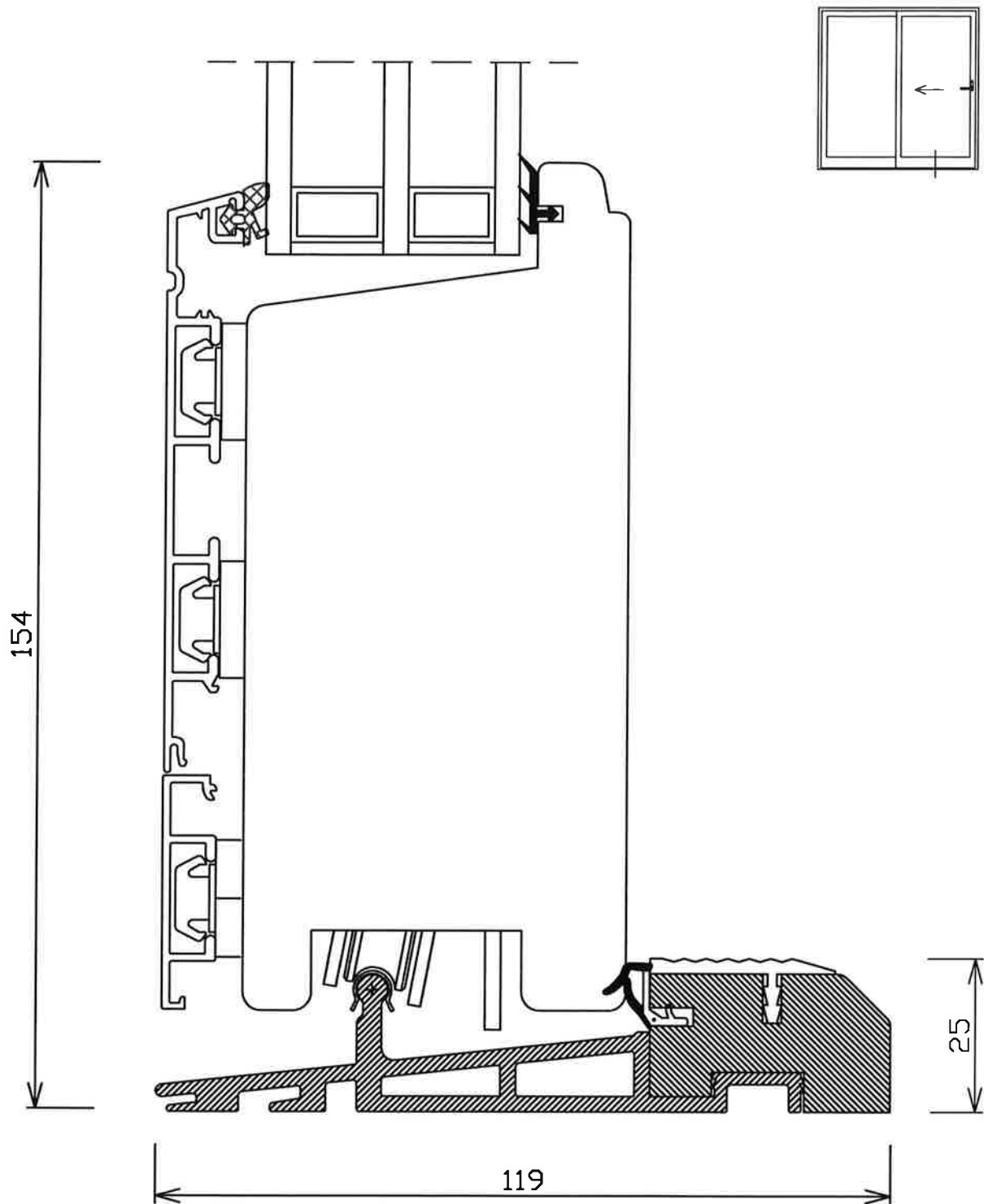

# SKALLEVOLD SYSTEM

Dato: 2015.03.19

Vertikal snitt

Teg.nr. 1056 - 2015

Skyvedør

M=1:1

firmapost@skallevold.no  
 tel (+47) 33 37 22 50  
 fax (+47) 33 37 22 51

Erstattet av:

Erstatning for:

Terskel og åpningsramme

Skallevold Trevaresalg AS  
 Granborgveien 5  
 N-3153 TOLVSRØD, NORWAY

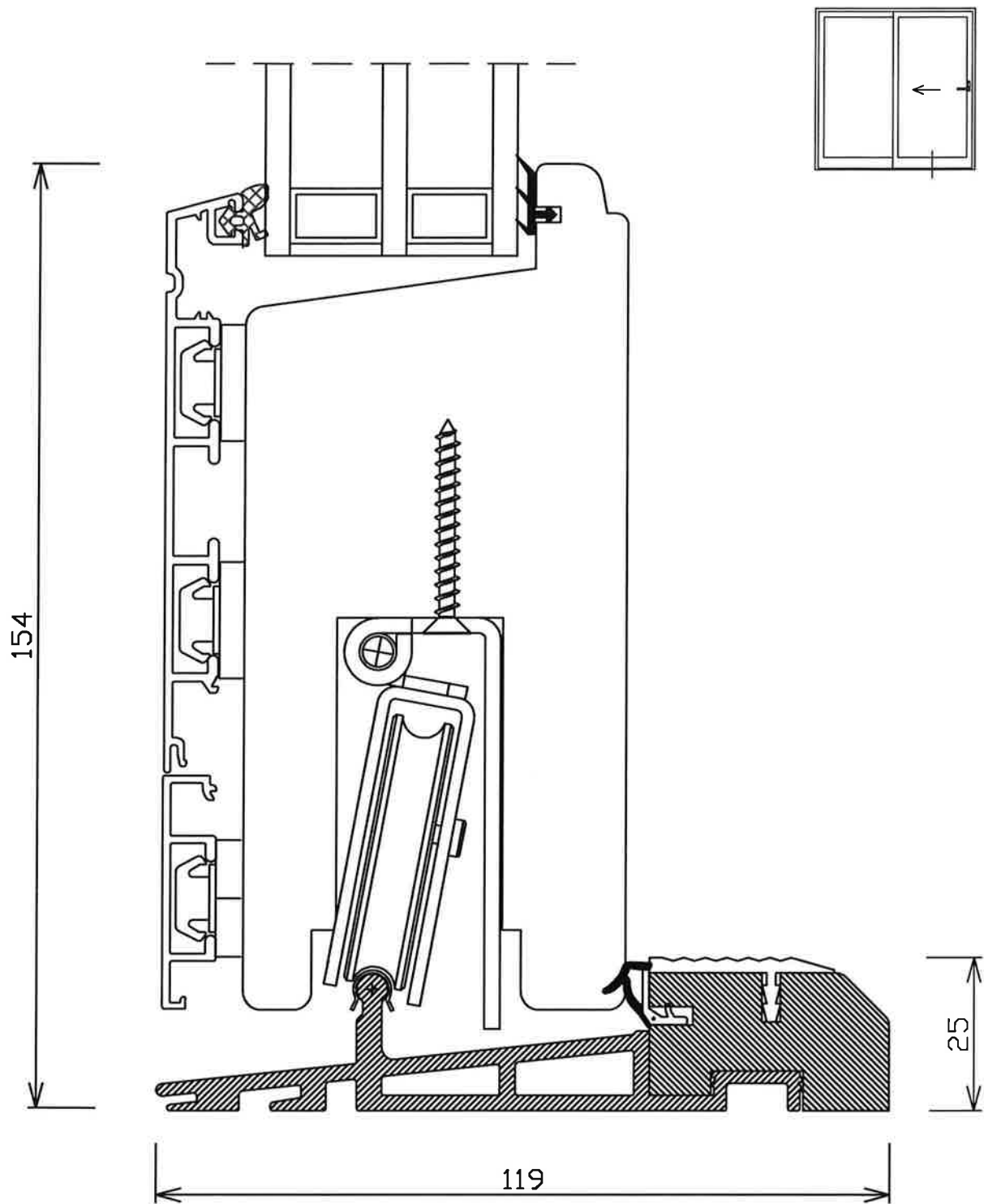

# SKALLEVOLD SYSTEM

|   |                |              |  |                 |
|---|----------------|--------------|--|-----------------|
| Dato: 2015.03.19                          | Vertikal snitt | <b>M=1:1</b> | firmapost@skallevold.no<br>tel (+47) 33 37 22 50<br>fax (+47) 33 37 22 51      |                 |
| Teg.nr. 1057 - 2015                       | Skyvedør       |              | Erstattet av:  | Erstatning for: |
| <b>Terskel og åpningsramme (hjulsett)</b> |                |              | <b>Skallevold Trevaresalg AS</b><br>Granborgveien 5<br>N-3153 TOLVSRØD, NORWAY |                 |
|   |                |              |  |                 |