

# LEIAB

F Ö N S T E R

TEL: +46 496 107 10 FAX: +46 496 211 60  
S-570 30 MARIANNELUND SWEDEN

BENÄMNING/NAME:  
INÅTGÅENDE FÖNSTERDÖRR  
BOTTENSTYCKE

BETECKNING/TYPE:  
LID1101

SKALA/SCALE:  
1:1

RITAD AV/DRAWN BY:  
TG

REV:

DATUM/DATE:  
20060109

RITN.NR/DRAWING NO.

31 31 22-01

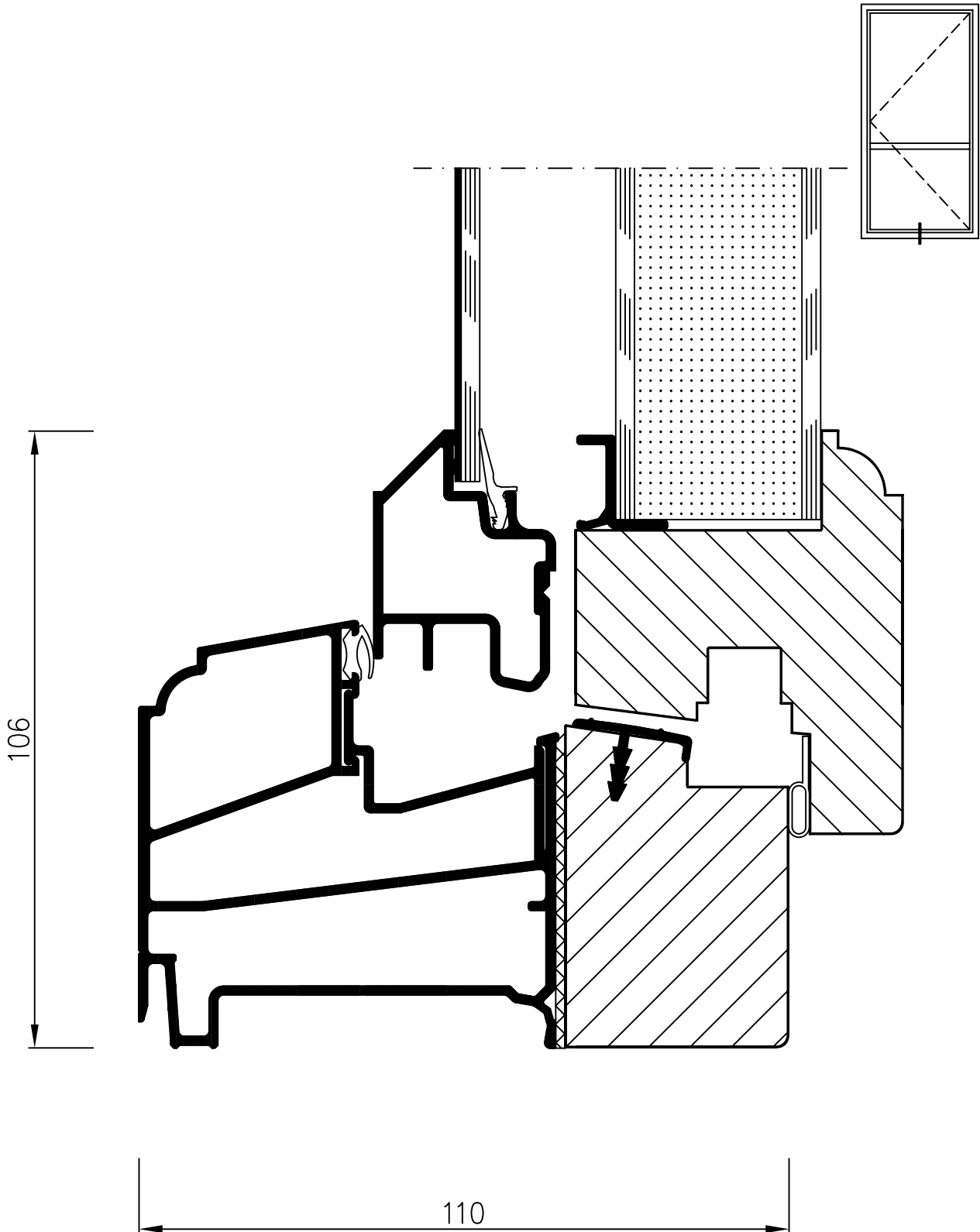

# LEIAB

F Ö N S T E R

TEL: +46 496 107 10 FAX: +46 496 211 60  
S-570 30 MARIANNELUND SWEDEN

BENÄMNING/NAME:  
INÅTGÅENDE FÖNSTERDÖRR  
BRÖSTNINGSPOST

BETECKNING/TYPE:  
LID1101

SKALA/SCALE:  
1:1

RITAD AV/DRAWN BY:  
TG

REV:

DATUM/DATE:  
20060109

RITN.NR/DRAWING NO.

31 31 22-02

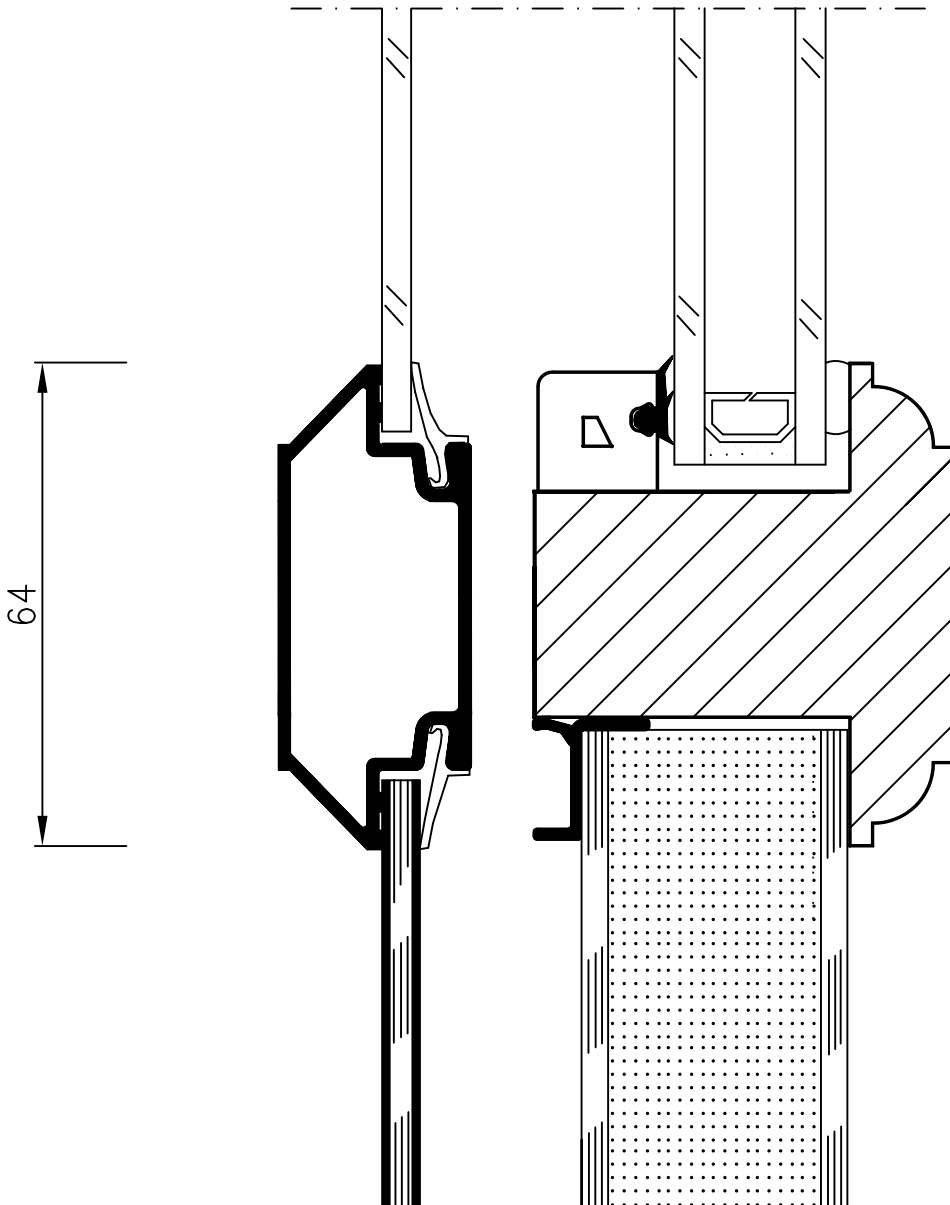
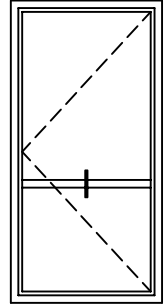

# LEIAB

F Ö N S T E R

TEL: +46 496 107 10 FAX: +46 496 211 60  
S-570 30 MARIANNELUND SWEDEN

BENÄMNING/NAME:  
INÅTGÅENDE FÖNSTERDÖRR  
ÖVERSTYCKE

BETECKNING/TYPE:  
LID1101

SKALA/SCALE:  
1:1

RITAD AV/DRAWN BY:  
TG

REV:

DATUM/DATE:  
20060109

RITN.NR/DRAWING NO.

31 31 22-03

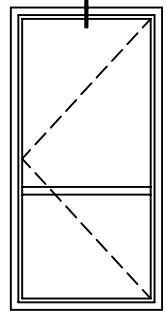

110

106

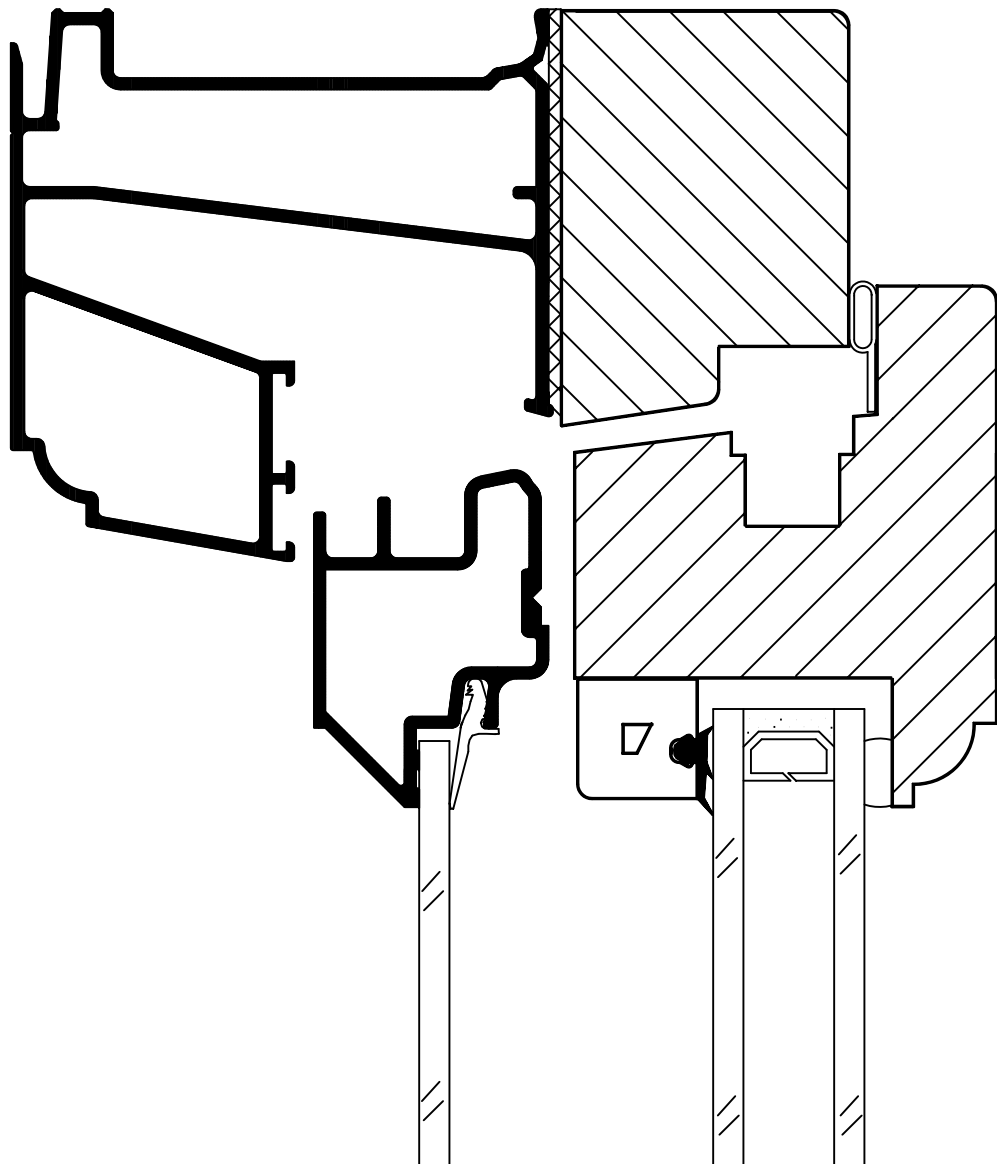

# LEIAB

F Ö N S T E R

TEL: +46 496 107 10 FAX: +46 496 211 60  
S-570 30 MARIANNELUND SWEDEN

BENÄMNING/NAME:  
INÅTGÅENDE FÖNSTERDÖRR  
SIDOSTYCKE

BETECKNING/TYPE:  
LID1101

SKALA/SCALE:  
1:1

RITAD AV/DRAWN BY:  
TG

REV:

DATUM/DATE:  
20060109

RITN.NR/DRAWING NO.

31 31 22-04

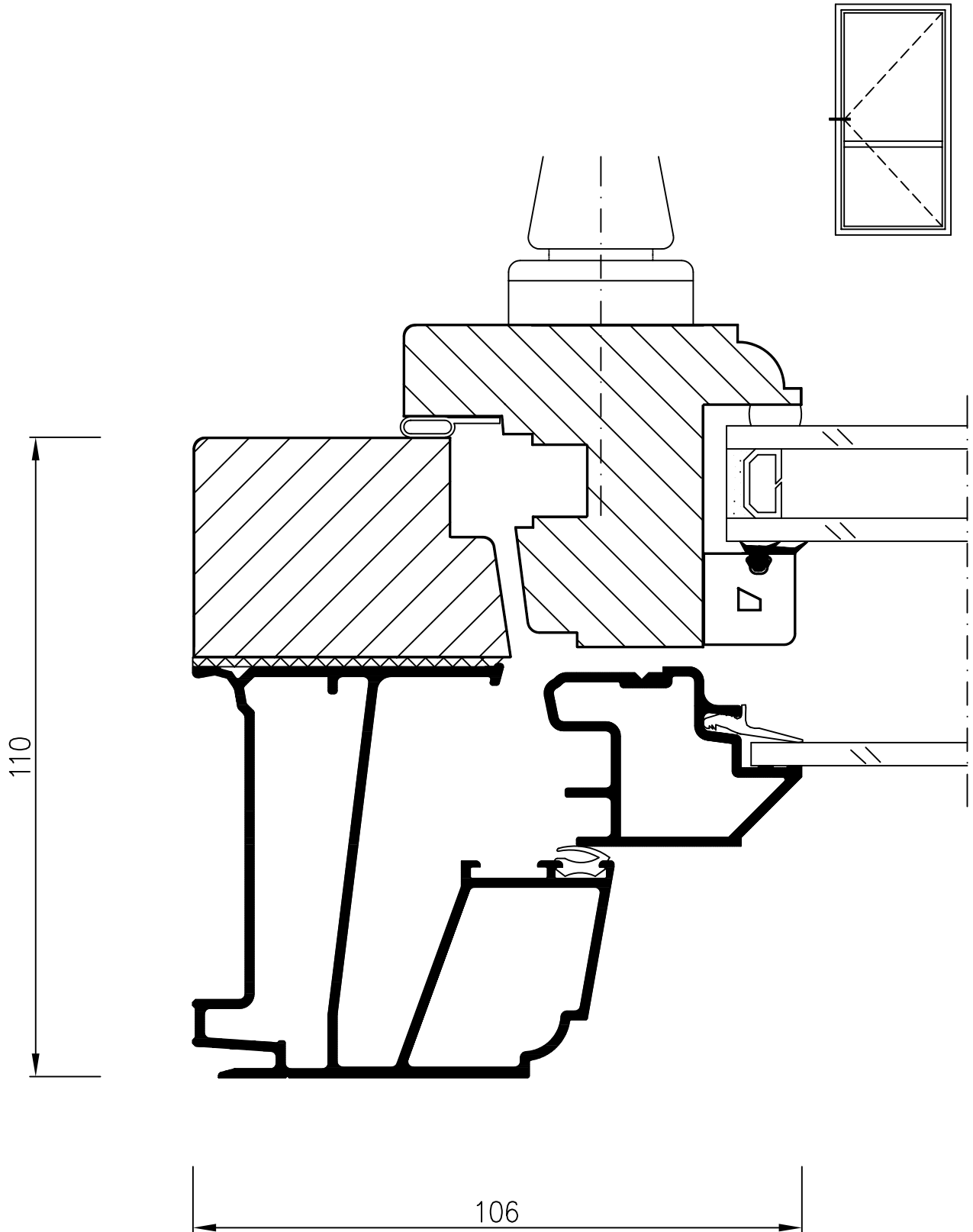

# LEIAB

F Ö N S T E R

TEL: +46 496 107 10 FAX: +46 496 211 60  
S-570 30 MARIANNELUND SWEDEN

BENÄMNING/NAME:  
INÅTGÅENDE FÖNSTERDÖRR  
SIDOSTYCKE

BETECKNING/TYPE:  
LID1101

SKALA/SCALE:  
1:1

RITAD AV/DRAWN BY:  
TG

REV:

DATUM/DATE:  
20060109

RITN.NR/DRAWING NO.

31 31 22-05

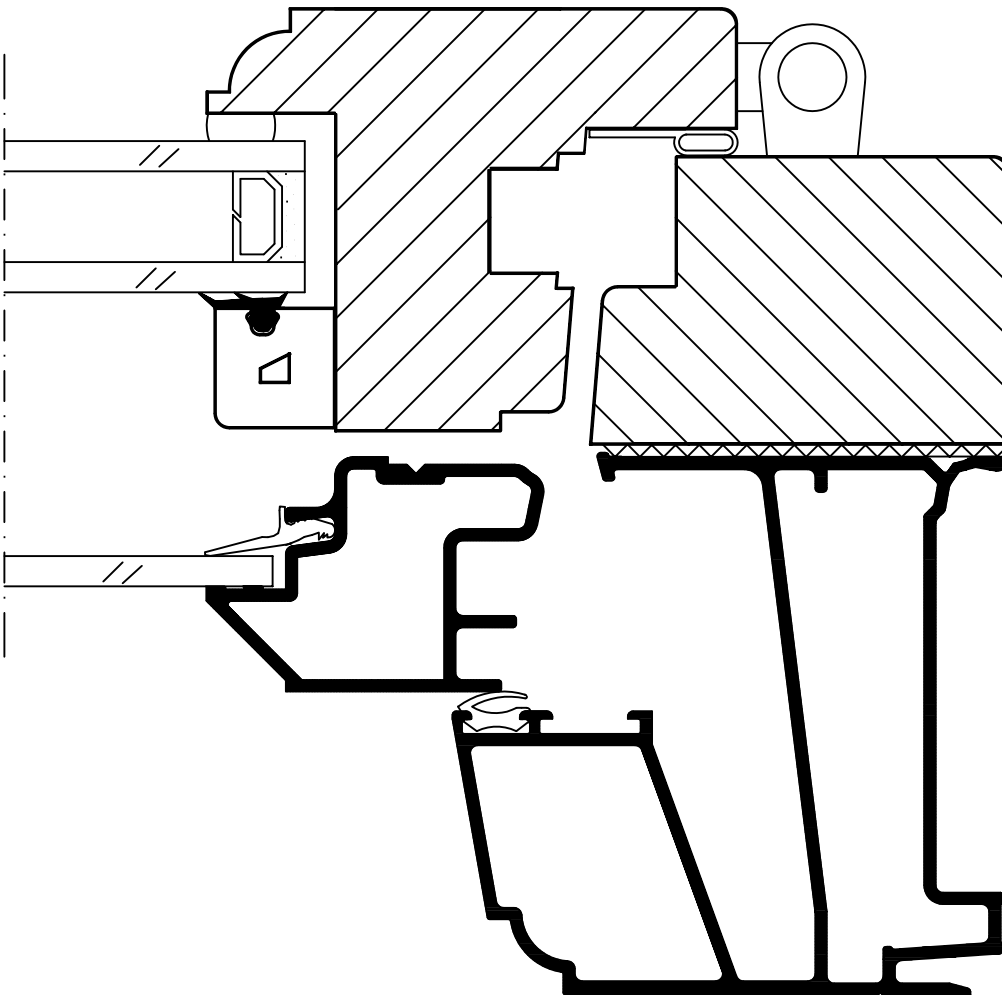
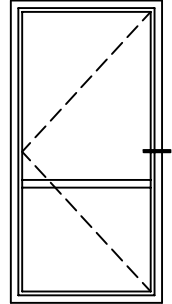

106

110

# LEIAB

F Ö N S T E R

TEL: +46 496 107 10 FAX: +46 496 211 60  
S-570 30 MARIANNELUND SWEDEN

BENÄMNING/NAME:  
INÅTGÅENDE FÖNSTERDÖRR  
PARDÖRR

BETECKNING/TYPE:  
LID1101

SKALA/SCALE:  
1:1

RITAD AV/DRAWN BY:  
TG

REV:

DATUM/DATE:  
20060109

RITN.NR/DRAWING NO.

31 31 22-06

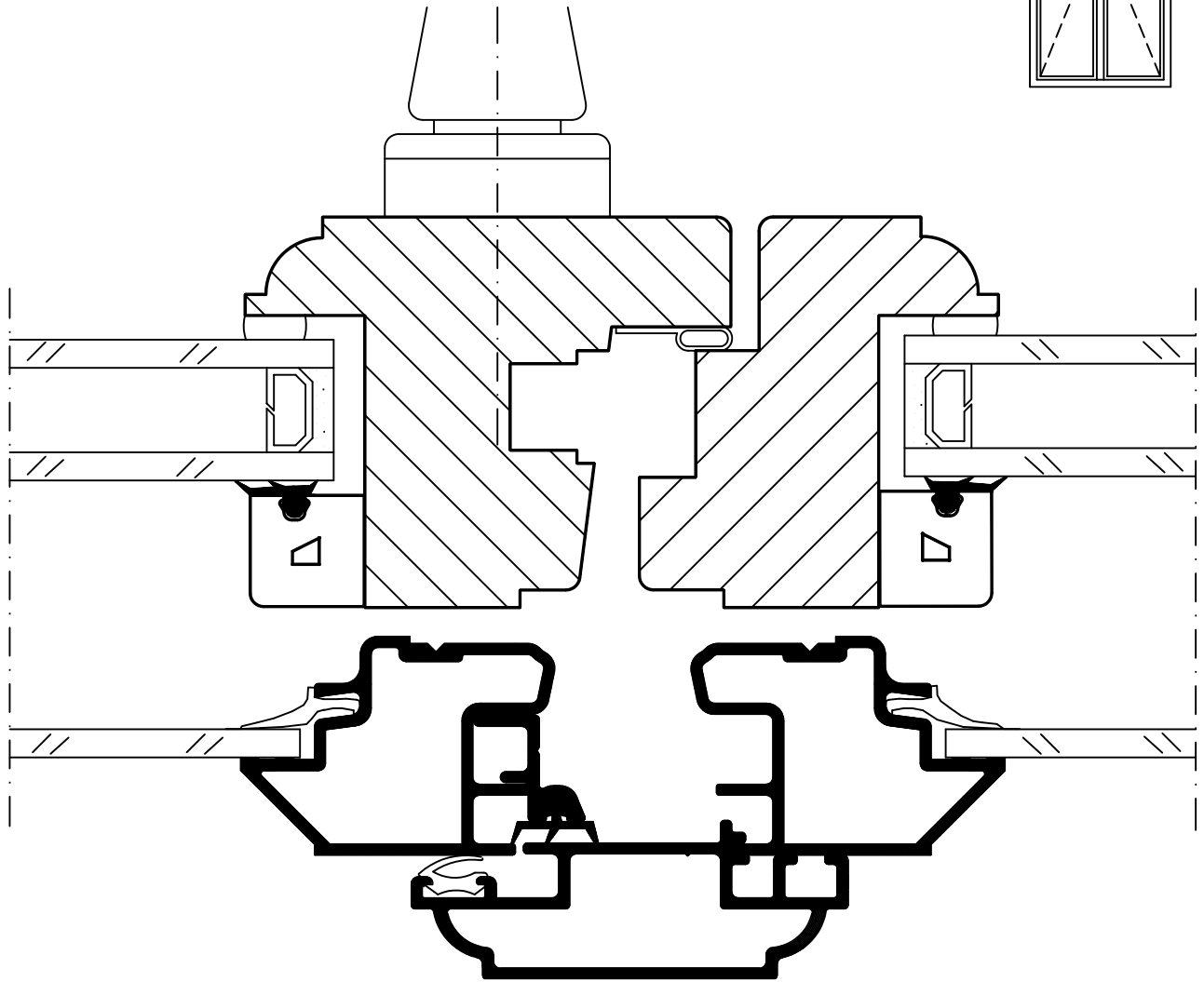
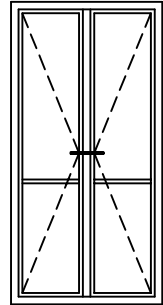

107